

# MINI CRAWLER EXCAVATORS

E17C | E19C | E26C | E30C | E37C | E57C | E60C



# The right tool for the job.

New Holland mini crawler excavators have a capacity range from 1.7 to 6.0 tonnes. With a choice of canopy, cab and SR short radius zero tail swing versions to choose from, there is the right model ideally suited to landscaping, amenity work, agriculture, horticulture, nurseries, vineyards, estate management and general contracting. Varied applications include track, irrigation and drainage scheme construction and maintenance through to fence, temporary building and crop support erection.

With hydraulically powered attachments to include soil augers, flail hedge and verge mowers, cutterbars and saws, the boom and dipper offer power arm versatility but with the build strength of an excavator. The same boom and dipper can work hydraulic shears, breakers and heavy duty items to include stump grinders.

Need more? With the Object Handling Kit installed, all models can be used to raise heavy suspended loads using a lifting hook on the bucket linkage. All this versatility from New Holland agricultural dealers.

## Small in size. Big on performance. Huge in versatility.

Compact dimensions enable New Holland mini-excavators to access difficult work areas. Compact dimensions are matched to high performance. Designed for day-long working, each model has class leading excavation performance with the versatility to power a wide range of attachments.



Models	Cab / Canopy	Power (hp)	Operating Weight* (Cab / Canopy) (kg)	Design	Rear overhang (mm)	Blade width (mm)	Max digging depth (Short arm / Long arm) (mm)	Max dump height (Short arm / Long arm) (mm)
E17C	- / ●	16	- / 1770	SR	0	990 - 1300	- / 2350	- / 2670
E19C	○ / ○	16	1995 / 1855	Conventional	440	980 - 1250	- / 2405	- / 2680
E26C	○ / ○	24.4	2650 / 2500	SR	0	1500	- / 2645	- / 3030
E30C	○ / ○	24.4	3005 / 2895	SR	0	1550	- / 2720	- / 3030
E37C	○ / ○	24.4	3760 / 3620	SR	0	1740	- / 3440	- / 3615
E57C	● / -	66.9	5500 / -	Conventional	690	1920	3820 / 4060	4050 / 4180
E60C	● / -	66.9	5900 / -	Medium SR	80	2000	3570 / 3990	3930 / 4100

● Standard ○ Optional - Not available \* Weight with full fuel tank, operator & bucket



## Designed around you.

Slim frame pillars ensure excellent all-round visibility, with a good view of the boom and dipper. When working in a confined area or between valuable crops such as in a vineyard, nursery or an orchard, a New Holland mini-excavator can be operated with absolute precision for minimal disruption. New Holland E17C mini-excavators are fitted with a canopy only, while the E19C, E26C, E30C and E37C are offered with a choice of canopy or full cab. The E57C and E60C are cab only. All variants are ROPS roll-over (with the exception of E17C), TOPS tip-over and FOPS falling-object compliant to ISO standards. Low noise and vibration levels ensure extended work periods can be undertaken in comfort with no compromise in operator safety.



- Adjustable suspension seat





- Powerful ventilation for cooling or heating
- Automatic climate control as standard on E57C and E60C



- Integrated cup holders are fitted to the E26C and above



- E26C and above have a lockable cubby under the seat



- Adjustable wrist rests



- Front screen opens or can be raised clear



- Standard hands free feature available on E57C and E60C
- Control your mobile phone and radio via Bluetooth

## More power, more productivity, more value.

A comfortable operator is a safe and productive operator. All models have excellent ergonomics, with all key controls positioned for easy access. The shape of the joysticks enables the operator to choose their preferred method of working the key excavator functions, allowing both gripped and palm down operating positions. The armrests adjust to deliver the required level of support and the foot pedals on the more compact models fold to increase floor space. Getting in and out the machine is eased by the left side-console tilting out of the way, locking the hydraulics at the same time to prevent accidental operation.

- All controls are within easy reach
- Joysticks positioned for ease of use
- Safety lock prevents exit while hydraulic controls are live





- Standard digital side console on E17C, E19C, E26C, E30C and E37C
- Sealed against dust and moisture
- Integrated code anti-theft system
- Hour meter, engine speed and warning lights
- Fuel level and coolant temperature gauges



- Standard digital 14.5cm colour LCD touchscreen display on E57C and E60C
- Displays engine speed and coolant temperature
- Hydraulic oil temperature
- Fuel level
- Maintenance information to include fault codes and diagnostics
- Input for rear view camera



- E17C to E37C joystick features full proportional control
- Optional integral buttons for auxiliary hydraulics



- E57C and E60C joystick features full proportional control
- Optional additional auxiliary controls on left joystick



- Fold-up travel pedals are fitted to all models except the E17C

# Smooth control, powerful performance.

The efficient conversion of engine power into hydraulic muscle lies behind the efficiency of New Holland mini-excavators. All models have three separate pumps to deliver optimised performance when travelling between sites or using the dozer blade, when working with the excavator and when driving hydraulic attachments. For demanding auxiliary attachments, a fourth pump option is available for the E57C and E60C.

To ensure smooth operation, valves control the flow of oil as the rams are fully extended and retracted, automatically providing a cushion effect to smooth the operation of all key functions. In work this reduces shock loads transferred to the machine and operator, reducing fatigue. This feature is further enhanced by the inclusion of an accumulator within the hydraulic circuit.

To further boost performance, the top two models have hydraulic flow summation. This advanced system delivers the enhanced proportional control typically restricted to high capacity excavators exceeding 20t capacity.

#### Cushioned rams for:

- Smoother operation
- Greater operator comfort
- Reduced machine wear

#### Hydraulic accumulator delivers:

- Cushioned shock loads
- Oil leak compensation
- Vibration damping
- Emergency hydraulic function

#### Separate oil pumps deliver:

- Cooler running
- Greater efficiency
- Faster hydraulic response
- Dedicated flow to meet demand
- Fourth pump option E57C and E60C





## Long and short arm choice

Specify your E57C or E60C mini-excavator with the arm length to best suit your requirements.

Models	Short arm length (mm)	Long arm length (mm)
E17C	-	1120
E19C	-	1120
E26C	-	1350
E30C	-	1350
E37C	-	1600
E57C	1600	1900
E60C	1480	1900

## Ample boom swing angles

- Efficient parallel digging: good for working along side obstacles
- Less time: no need to reposition the machine, get the job done faster
- Better visibility: larger left swing angle to the side of the door

Models	Left swing (degrees)	Right swing (degrees)
E17C	70	54
E19C	60	60
E26C	75	50
E30C	75	50
E37C	75	50
E57C	80	50
E60C	70	50

## Auxiliary hydraulic power and versatility

- Power for grabs and clamshell buckets
- Reversible flow for soil augers
- High capacity constant flow for flails and cutterbars
- Power for hydraulic breakers and hammers

## Clever features

- Hydraulic flow summation system
- Boom hold
- Swing parking brake
- Excellent hydraulic hose protection
- Cylinder protection covers on boom, dipper and dozer

## Boom pivot pins secured by plate and bolt

- Reduced lateral movement
- Long service life
- Reliable performance in tough conditions
- Lower whole life operating costs

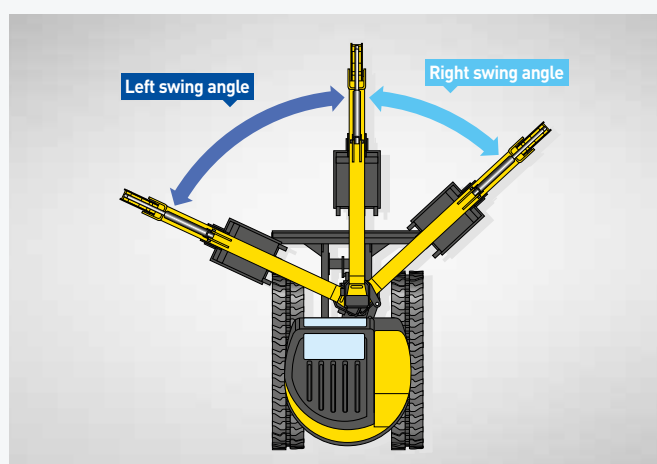
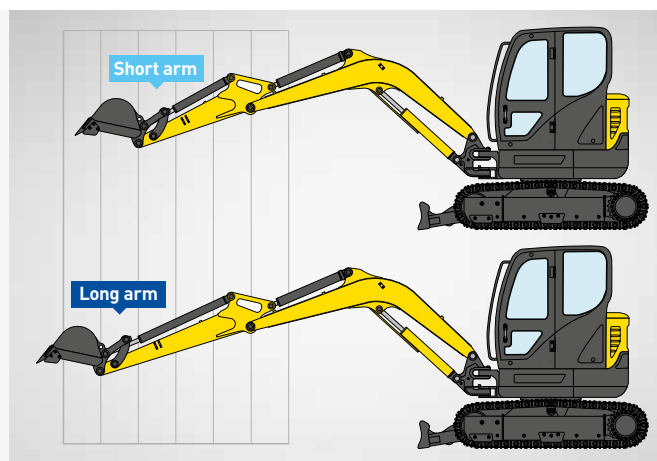

## Excellent stability, maximum traction.

Built for versatility, New Holland mini-excavators have powerful traction matched to a low centre of gravity for stability across difficult terrain. The dozer blade, which is lowered for stability when excavating, features excellent geometry for levelling and grading. Dependent upon model, there are four choices of track design, with the E17C and E19C also featuring hydraulic variable track width.

All models now feature Auto Shift Down on the move gear changing. On steep inclines, the two-speed drive can be set to automatically default into low range to maintain forward speed with no input from the operator.



### Auto Shift Down

- Always travel at the machine's highest speed. Auto Shift Down is available on all models

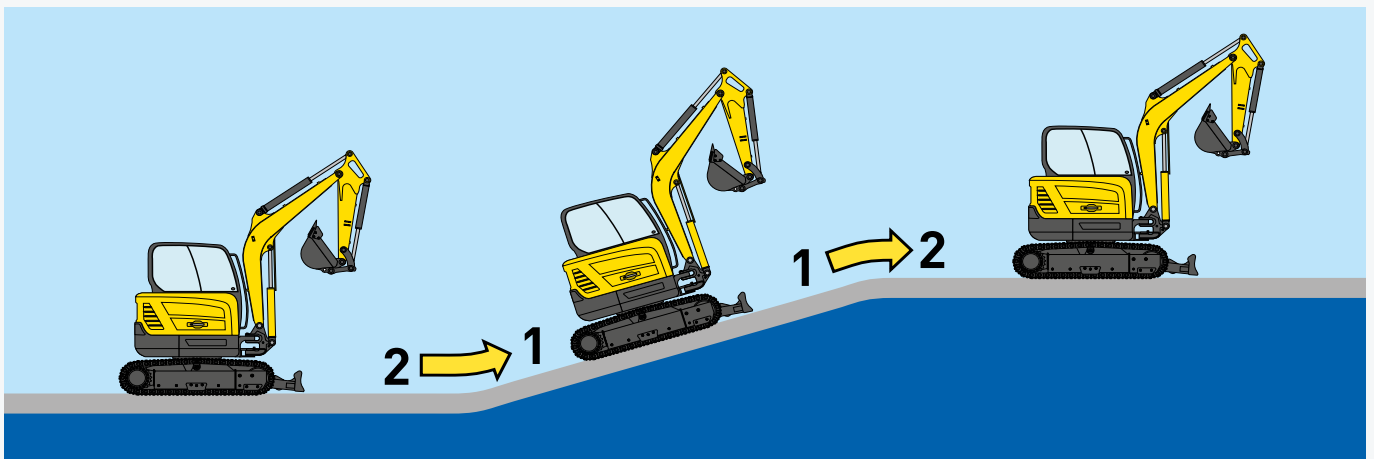

- E17C travel motor hoses run inside the track frame for protection
- Excellent ground clearance, up to 170mm on E17C
- Double-flange rollers feature as standard to minimise the risk of de-tracking



- E17C and E19C track width adjusts from 990mm to 1300mm and from 980mm to 1250mm respectively
- This function is hydraulically controlled from the operator seat



- Dozer blade extenders are standard on variable track width E17C and E19C models
- Simple pin lock system



#### Wide tracks offering

		E17C	E19C	E26C	E30C	E37C	E57C	E60C
<b>Tracks width</b>								
<b>1 - Rubber tracks</b>	(mm)	230	230	250	300	300	400	400
<b>2 - Rubber link tracks</b>	(mm)	-	-	-	-	-	400	400
<b>3 - Steel tracks</b>	(mm)	-	-	-	-	300	380 / 450	380 / 450
<b>4 - Steel tracks with rubber pads</b>	(mm)	-	-	-	-	-	400	400

# Efficient, Powerful, Dependable.

New Holland mini-excavators are compliant with Stage V emission regulations and employ different after treatment technologies to achieve this. Each model has a power unit selected to match the excavators size and capacity. This ensures optimised performance and fuel economy. To further enhance economy, the E37C, E57C and E60C are fitted with Auto-idle.

Models	Power (hp)	Emission Level	Stage V Technology
E17C	16	Stage V	Mechanical - No ATS
E19C	16	Stage V	Mechanical - No ATS
E26C	24.4	Stage V	Mechanical - No ATS
E30C	24.4	Stage V	Mechanical - No ATS
E37C	24.4	Stage V	Mechanical + CEGR
E57C	66.9	Stage V	Electronic + CEGR + DPF
E60C	66.9	Stage V	Electronic + CEGR + DPF



## Auto-idle (E37C, E57C and E60C)

When the hydraulics or traction motors are not demanding oil, the engine speed is reduced to idle with no input required from the operator. This feature can be turned on or off via a simple switch on the main console.

- Reduced fuel consumption
- Low engine noise when not working
- Reduced wear

# Attachments for dedicated efficiency.

A mini-excavator is far more versatile than you think. With the right attachment, these machines can be used for a wide and diverse range of duties to include fence and temporary crop support erection through to hedge and verge cutting. With New Holland models you have the added advantage of high constant hydraulic flow. Powering demanding attachments is a key New Holland advantage. The range of attachments purpose developed for mini-excavators continues to increase, further increasing future versatility.

## Hydraulic Quick Coupler

- Hands-free coupling and release of buckets
- Safe swap between large, heavy attachments
- Mechanical quick lock attachment brackets are also available

## Attachments available

- Standard or Ditching Bucket
- Cutter Bar
- Hydraulic Hammer
- Flail head
- Mechanical & Hydraulic coupler



**Standard or ditching bucket**

Standard excavator or specialist ditching buckets can be fitted quickly and easily.



**Flail head**

Versatile flail head ideal for general maintenance and verge mowing.



**Cutterbar**

Hydraulic cutterbar attachments for hedge trimming and pruning.



**Hammer**

Dedicated hammer circuit option for high impact attachments.

# Ease of care protects your investment.

Preparing a New Holland C series mini-excavator for work takes less time. Routine maintenance tasks are simplified, with all key check and service points grouped together. For secure transport on a trailer, easy access lashing points are fitted.



- Sight glass levels allow hydraulic oil levels to be checked quickly and with no need to lift the engine hood

## Long service intervals

- Main pivots. Lubricate every 250 hours
- Polymer shims. Long life. Maintenance free
- Extended life hydraulic filters. 1,000 hour change interval
- Long-life hydraulic oil. 2,000 hour change interval



- Centralised grease points



- Forward tilting cab eases maintenance access



- A remote electric refuelling pump is available on E57C and E60C models

# New Holland Services.



## Finance tailored to your business

CNH Industrial Capital, the financial services company of New Holland, is well established and respected within the agricultural sector. Advice and finance packages tailored to your specific needs are available. With CNH Industrial Capital, you have the peace of mind that comes from dealing with a financing company that specialises in agriculture.



## Trained to give you the best support

Your dedicated New Holland dealer technicians receive regular training updates. These are carried out both through on-line courses as well as intensive classroom sessions. This advanced approach ensures your dealer will always have the skills needed to look after the latest and most advanced New Holland products.



MyNew Holland



Harvest Excellence



MyPLM<sup>®</sup>Connect Farm

## New Holland Apps

MyNew Holland - Harvest Excellence - Grain Loss Calculator - Product Apps - New Holland Weather - MyPLM<sup>®</sup>Connect Farm - PLM Solutions - PLM Calculator - PLM Academy



## New Holland Style

Want to make New Holland a part of your everyday life? Browse the comprehensive selection on [www.newhollandstyle.com](http://www.newhollandstyle.com). A whole range of items are available including hard wearing work clothing and a vast selection of scale models, together with so much more. New Holland. As individual as you.

Models	E17C	E19C	E26C	E30C	E37C	E57C	E60C
<b>Engines</b>	Kubota	Kubota	Kubota	Kubota	Yanmar	Yanmar	Yanmar
<b>Type</b>	D902	D902	D1305	D1305	3TNV88F	4TNV98C	4TNV98C
N° of cylinders	3	3	3	3	3	4	4
Displacement (cm³)	898	898	1261	1261	1642	3319	3319
Compliant with engine emissions regulations	Stage V	Stage V	Stage V	Stage V	Stage V	Stage V	Stage V
Rated horse power [kW/hp(CV)]	11.9/16	11.9/16	18.2/24.4	18.2/24.4	18.2/24.4	49.9/66.9	49.9/66.9
⊘ rated speed (rpm)	2400	2400	2400	2400	2200	2400	2400
Max torque (Nm)	54	54.6	81	81	89	235	235
⊘ rated speed (rpm)	1900	1800	1600	1600	1200	1550	1560
Diesel tank capacity (Litres)	20	21	30	30	40	120	82
<b>Hydraulic system</b>							
Variable displacement axial piston pumps	●	●	●	●	●	●	●
Maximum flow (lpm)	2 x 18.8	2 x 18.8	2 x 27.6	2 x 27.6	2 x 37.4	2 x 57.8	2 x 55
Maximum pressure (bar)	210	210	220	220	230	220	220
Gear pump delivery flow (lpm)	11.3	11.3	19.6	19.6	23.1	38.4	36.6
Gear pump delivery pressure (bar)	170	170	175	175	205	220	220
Hammer Circuit 1-way flow (lpm)	-	-	-	-	-	57.8	55
Hammer Circuit 1-way pressure (bar)	-	-	-	-	-	220	220
1st Auxiliary 2-way Circuit flow (lpm)	30.1	28.8	47.2	47.2	60.5	57.8	55
1st Auxiliary 2-way Circuit pressure (bar)	170	170	175	175	205	220	220
2nd Auxiliary 2-way Circuit flow (lpm)	-	-	47.2	47.2	60.5	30	30
2nd Auxiliary 2-way Circuit pressure (bar)	-	-	175	175	205	160	160
<b>Transmission</b>							
Type	two speed	two speed	two speed	two speed	two speed	two speed	two speed
Travel Speed - Low (1st) (km/h)	2.1	2.1	2.4	2.4	2.3	2.1	2.0
Travel Speed - High (2nd) (km/h)	4.3	4.1	4.5	4.3	4.4	4.1	3.9
<b>Slewing</b>							
Slewing speed (rpm)	9.5	9.9	9.1	9.1	9.5	9.1	8.8
Boom slewing angle - left/right (degrees)	70 / 54	60 / 60	75 / 50	75 / 50	75 / 50	80 / 50	70 / 50
<b>Transport feature*</b>							
Weight - Cab version (kg)	-	1905	2560	2915	3660	5310	5710
Weight - Canopy version (kg)	1680	1765	2410	2805	3520	-	-
<b>A</b> - Max length - short / long arm (mm)	- / 3510	- / 3855	- / 4100	- / 4220	- / 4815	5900 / 5930	5600 / 5625
<b>B</b> - Max height (mm)	2320	2300	2500	2500	2500	2550	2550
<b>C</b> - Max width (mm)	990 - 1300	980 - 1250	1500	1550	1740	1900	2000
<b>Operating weight**</b>							
Cab version (kg)	-	1995	2650	3005	3760	5500	5900
Canopy version (kg)	1770	1855	2500	2895	3620	-	-





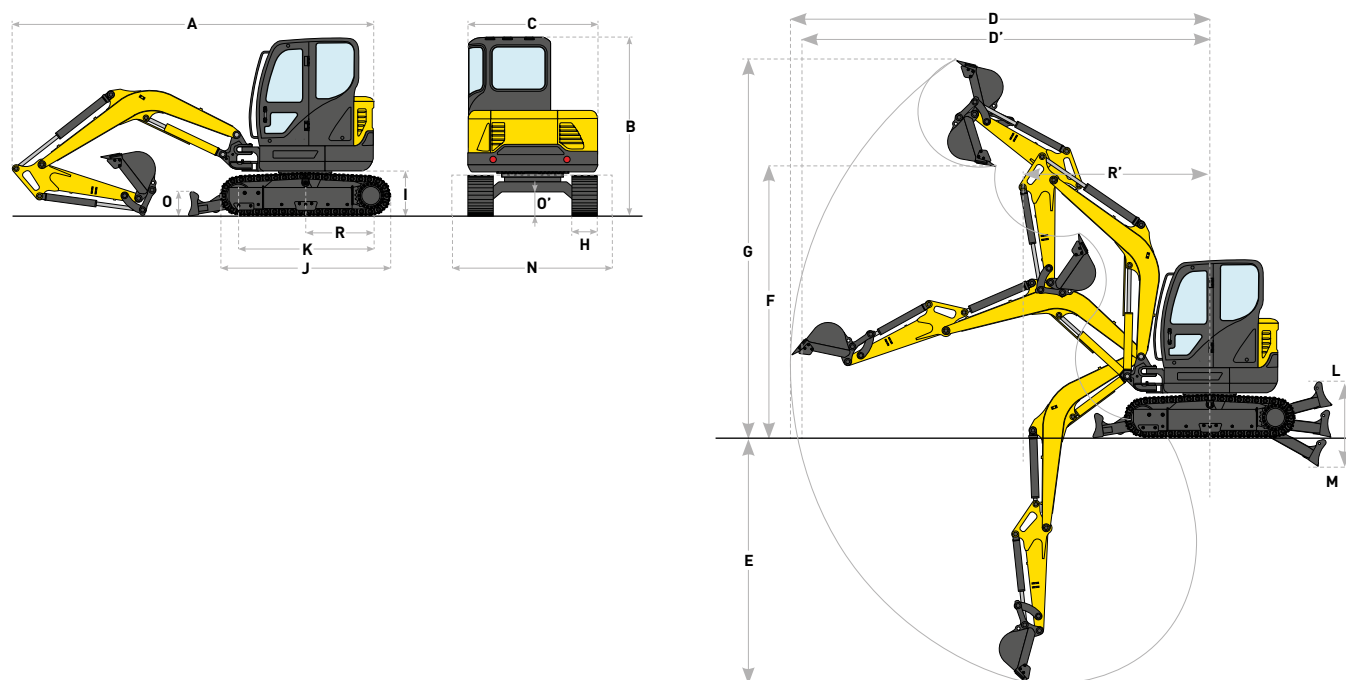

● Standard - Not available \* Weight is with full fuel tank, without operator, without \*\* Includes operator, full fuel tank and one bucket















Models		E17C	E19C	E26C	E30C	E37C	E57C	E60C
<b>Dimensions</b>								
<b>R</b> - Rear end swing radius	(mm)	645	1065	775	775	870	1650	1080
<b>R'</b> - Min front slew radius (Cab / Canopy)	(mm)	1600	1615 / 1660	1980 / 1970	2055 / 2090	2350 / 2330	2350	2420
<b>H</b> - Track width	(mm)	230	230	250	300	300	400	400
<b>I</b> - Ground clearance of rear end	(mm)	440	415	510	540	540	690	660
<b>J</b> - Overall Length of Crawler	(mm)	1590	1590	1910	1970	2130	2530	2530
<b>K</b> - Center distance of tumblers	(mm)	1230	1230	1490	1550	1700	1990	1990
<b>L</b> - Blade max lifting	(mm)	285	170	330	350	375	390	200
<b>M</b> - Blade max lowering	(mm)	225	240	380	370	390	590	700
<b>N</b> - Blade width	(mm)	990 / 1300	980 / 1250	1500	1550	1740	1920	2000
<b>O</b> - Blade height	(mm)	250	250	300	300	370	350	350
<b>O'</b> - Ground clearance of undercarriage	(mm)	170	150	290	290	290	380	380















Models		E17C	E19C	E26C	E30C	E37C	E57C	E60C		
<b>Digging performances</b>										
<b>Arm</b>		<b>Long</b>	<b>Long</b>	<b>Long</b>	<b>Long</b>	<b>Long</b>	<b>Short</b>	<b>Long</b>	<b>Short</b>	<b>Long</b>
Dipperstick	(mm)	1120	1120	1350	1350	1600	1600	1900	1480	1900
Dipperstick Breakout force (ISO)	(kN)	7.6	8.5	12.8	12.4	16.9	31.9	28.7	26.5	22.4
Bucket Breakout force (ISO)	(kN)	15.5	15.1	21.1	20.1	30.9	42.4	42.4	40.9	40.9
<b>D</b> - Max reach	(mm)	4030	4110	4680	4860	5605	6150	6400	6150	6480
<b>D'</b> - Max reach at ground level	(mm)	3940	4020	4540	4735	5495	6010	6270	6010	6350
<b>E</b> - Max digging depth	(mm)	2350	2405	2645	2720	3440	3820	4060	3570	3990
<b>F</b> - Max dump height	(mm)	2670	2680	3030	3030	3615	4050	4180	3930	4100
<b>G</b> - Max digging height	(mm)	3680	3785	4235	4405	5010	5780	5920	5680	5850







Load radius		1.5 (m)		2.0 (m)		2.5 (m)		
Load point height								
<b>E17C CANOPY - no bucket, std counterweight, rubber tracks</b>								
1.0 (m)	(kg)	Blade up	-	-	430	430	300	310
		Blade down	-	-	620*	460	470*	330
Ground level	(kg)	Blade up	600*	600*	390	390	280	290
		Blade down	600*	600*	820	420	580*	300
-1.0 (m)	(kg)	Blade up	630	630	390	390	280	280
		Blade down	1060	680	720*	420	520	300







Load radius		1.5 (m)		2.0 (m)		2.5 (m)		
Load point height								
<b>E19C CANOPY - no bucket, std counterweight, rubber tracks</b>								
1.0 (m)	(kg)	Blade up	-	-	530	490	380	350
		Blade down	-	-	660*	520	500*	370
Ground level	(kg)	Blade up	630*	630*	490	450	360	330
		Blade down	630*	630*	900*	480	630*	350
-1.0 (m)	(kg)	Blade up	790	710	490	450	350	330
		Blade down	1220*	770	810*	480	590*	350

Load radius		1.5 (m)		2.0 (m)		2.5 (m)		
Load point height								
<b>E19C CAB - no bucket, std counterweight, rubber tracks</b>								
1.0 (m)	(kg)	Blade up	-	-	610	560	430	400
		Blade down	-	-	660*	590	500*	430
Ground level	(kg)	Blade up	630*	630*	570	520	410	380
		Blade down	630*	630*	900*	560	630*	410
-1.0 (m)	(kg)	Blade up	910	820	570	520	410	380
		Blade down	1220*	880	810*	560	590*	400

Load radius		2.0 (m)		2.5 (m)		3.0 (m)		
Load point height								
<b>E26C CANOPY - no bucket, std counterweight, rubber tracks</b>								
1.0 (m)	(kg)	Blade up	760	620	530	440	400	340
		Blade down	1690*	670	1130*	480	900*	360
Ground level	(kg)	Blade up	710	570	500	410	380	310
		Blade down	1700*	620	1450*	440	1100*	340
-1.0 (m)	(kg)	Blade up	710	570	490	400	370	310
		Blade down	1910*	620	1360*	440	1030*	330

Load radius		2.0 (m)		2.5 (m)		3.0 (m)		
Load point height								
<b>E26C CAB - no bucket, std counterweight, rubber tracks</b>								
1.0 (m)	(kg)	Blade up	880	720	610	510	460	380
		Blade down	1470*	770	1030*	550	850*	410
Ground level	(kg)	Blade up	810	650	570	470	430	360
		Blade down	1580*	700	1420*	500	1070*	390
-1.0 (m)	(kg)	Blade up	800	650	560	460	430	350
		Blade down	2000*	700	1420*	490	1070*	380

Load radius		2.0 (m)		2.5 (m)		3.0 (m)		
Load point height								
<b>E30C CANOPY - no bucket, std counterweight, rubber tracks</b>								
1.0 (m)	(kg)	Blade up	-	-	660	510	490	390
		Blade down	-	-	1180*	550	930*	420
Ground level	(kg)	Blade up	880	660	610	470	470	360
		Blade down	1540*	720	1480	510	1110*	390
-1.0 (m)	(kg)	Blade up	890	670	610	470	460	360
		Blade down	1920*	720	1380*	510	1040*	390

Load radius		2.0 (m)		2.5 (m)		3.0 (m)		
Load point height								
<b>E30C CAB - no bucket, std counterweight, rubber tracks</b>								
1.0 (m)	(kg)	Blade up	-	-	730	570	550	430
		Blade down	-	-	1180*	610	930*	460
Ground level	(kg)	Blade up	980	740	690	530	520	410
		Blade down	1540*	800	1480*	570	1110*	440
-1.0 (m)	(kg)	Blade up	990	740	680	530	520	400
		Blade down	1920*	800	1380*	570	1040*	430

Load radius		2.0 (m)		3.0 (m)		4.0 (m)		
Load point height								
<b>E37C CANOPY - no bucket, std counterweight, rubber tracks</b>								
1.0 (m)	(kg)	Blade up	-	-	780	670	500	440
		Blade down	-	-	970*	730	690*	470
Ground level	(kg)	Blade up	1320*	1160	730	620	480	410
		Blade down	1320*	1280	1160*	680	770*	450
-1.0 (m)	(kg)	Blade up	1420	1170	720	610	480	410
		Blade down	2060*	1290	1140*	670	750*	450

Load radius		2.0 (m)		3.0 (m)		4.0 (m)		
Load point height								
<b>E37C CAB - no bucket, std counterweight, rubber tracks</b>								
1.0 (m)	(kg)	Blade up	-	-	830	710	540	470
		Blade down	-	-	970*	770	690*	500
Ground level	(kg)	Blade up	1320*	1230	780	670	510	440
		Blade down	1320*	1320*	1160*	730	770*	480
-1.0 (m)	(kg)	Blade up	1520	1240	770	660	510	440
		Blade down	2060*	1370	1140*	720	750*	480

Load radius		2.0 (m)		3.0 (m)		4.0 (m)		
Load point height								
<b>E57C CAB - long arm, no bucket, std counterweight, steel track (380mm)</b>								
1.0 (m)	(kg)	Blade up	-	-	1650	1290	1070	850
		Blade down	-	-	2450*	1510	1700*	1000
Ground level	(kg)	Blade up	1500*	1500*	1570	1210	1030	810
		Blade down	1500*	1500*	2830*	1430	1900*	960
-1.0 (m)	(kg)	Blade up	2740*	2260	1550	1190	1010	790
		Blade down	2740*	2720	2840*	1410	1940*	940

Load radius		2.0 (m)		3.0 (m)		4.0 (m)		
Load point height								
<b>E57C CAB - long arm, no bucket, extra counterweight (335kg), steel track (380mm)</b>								
1.0 (m)	(kg)	Blade up	-	-	1750	1360	1130	910
		Blade down	-	-	2450*	1510	1700*	1000
Ground level	(kg)	Blade up	1500*	1500*	1660	1290	1090	870
		Blade down	1500*	1500*	2830*	1430	1900*	960
-1.0 (m)	(kg)	Blade up	2740*	2400	1640	1260	1070	850
		Blade down	2740*	2720	2840*	1410	1940*	940

Load radius		2.0 (m)		3.0 (m)		4.0 (m)		
Load point height								
<b>E60C CAB - long arm, no bucket, std counterweight, steel track (380mm)</b>								
1.0 (m)	(kg)	Blade up	-	-	1410	1170	900	760
		Blade down	-	-	2640*	1300	1770*	850
Ground level	(kg)	Blade up	1360*	1360*	1320	1090	860	720
		Blade down	1360*	1360*	3050*	1220	1990*	800
-1.0 (m)	(kg)	Blade up	2470*	2110	1300	1070	840	700
		Blade down	2470*	2410	3020*	1200	2010*	780

Load radius		2.0 (m)		3.0 (m)		4.0 (m)		
Load point height								
<b>E60C CAB - long arm, no bucket, extra counterweight (670kg), steel track (380mm)</b>								
1.0 (m)	(kg)	Blade up	-	-	1740	1510	1130	1000
		Blade down	-	-	2650*	1660	1770*	1090
Ground level	(kg)	Blade up	1360*	1360*	1660	1430	1080	950
		Blade down	1360*	1360*	3070*	1580	2000*	1050
-1.0 (m)	(kg)	Blade up	2470*	2470*	1640	1410	1070	930
		Blade down	2470*	2470*	3030*	1560	2020*	1030

# New Holland Top Service: customer support and customer information.



### Top Availability

If you need information, or have an out of hours question, ring our toll-free number\*. All day, every day, we are just a call away.



### Top Speed

Express parts delivery: when you need it, where you need it!



### Top Priority

Fast-track solution during the season: because your harvest can't wait!



### Top Satisfaction

We drive and track the solution you need, keeping you informed: until you are 100% satisfied!



**For more details, ask your New Holland dealer!**

\* Calls to the Top Service team are free from landlines in the United Kingdom and Republic of Ireland. UK-based mobile calls are also free, but Republic of Ireland mobile users should call 01 2421881 and this will be charged at your standard network rate.

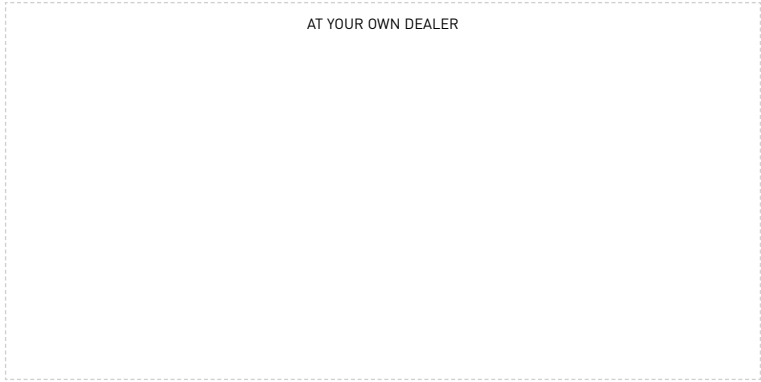

[www.newholland.com/uk](http://www.newholland.com/uk) - [www.newholland.com/ie](http://www.newholland.com/ie)

